

Modular valves type HQ, KQ, JPQ

flow control ISO 4401 sizes 06, 10, 16 and 25

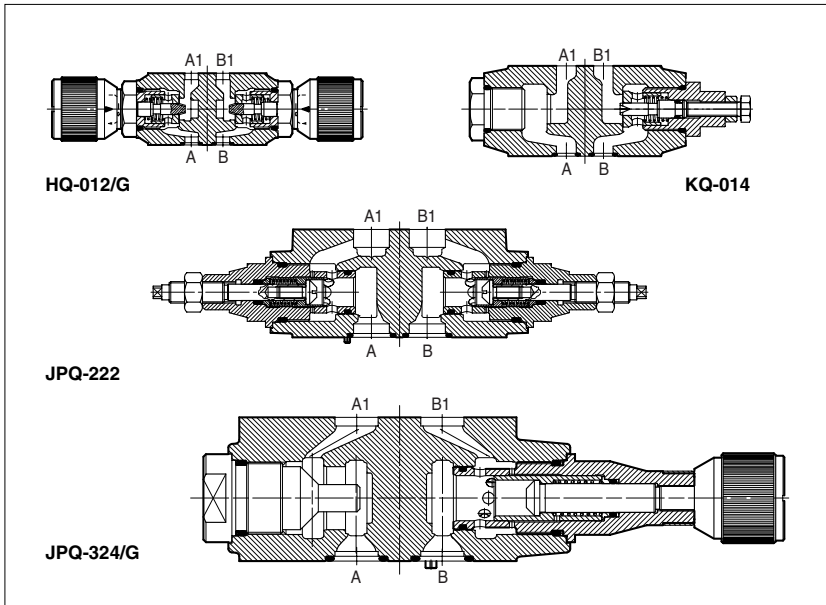

HQ, KQ and JPQ are flow throttling valves, not compensated, and with check valve to allow free flow in the opposite direction.

The flow adjustment is done by turning the setting screw in the normal model. Optional versions with a graduate micrometer knob are available on request.

Clockwise rotation increases the throttling (passage reduced).

HQ-0 = ISO 4401 size 06 interface: flow up to 25 l/min for /U option, up to 80 l/min for standard, pressure up to 350 bar

KQ-0 = ISO 4401 size 10 interface: flow up to 160 l/min, pressure up to 315 bar.

JPQ-2 = ISO 4401 size 16 interface: flow up to 200 l/min, pressure up to 350 bar.

JPQ-3 = ISO 4401 size 25 interface: flow up to 300 l/min, pressure up to 350 bar.

Valves designed to operate in hydraulic systems with hydraulic mineral oil or synthetic fluid having similar lubricating characteristics.

1 MODEL CODE

HQ-0

Modular flow control valve, size:
HQ-0 = 06
KQ-0 = 10
JPQ-2 = 16
JPQ-3 = 25

13

Configuration, see section 2

control of flow discharged from the actuator:

- 12** = double, acting on port A and B
- 13** = single, acting on port A
- 14** = single, acting on port B

control of flow entering the actuator:

- 22** = double, acting on port A and B
- 23** = single, acting on port A
- 24** = single, acting on port B

/G

**

Design number

/*

Synthetic fluids:
WG = water-glycol
PE = phosphate ester

Options
/U = better accuracy for reduced flow (only for HQ-0)
/G = adjustment by graduated micrometer

2 VALVE CONFIGURATION

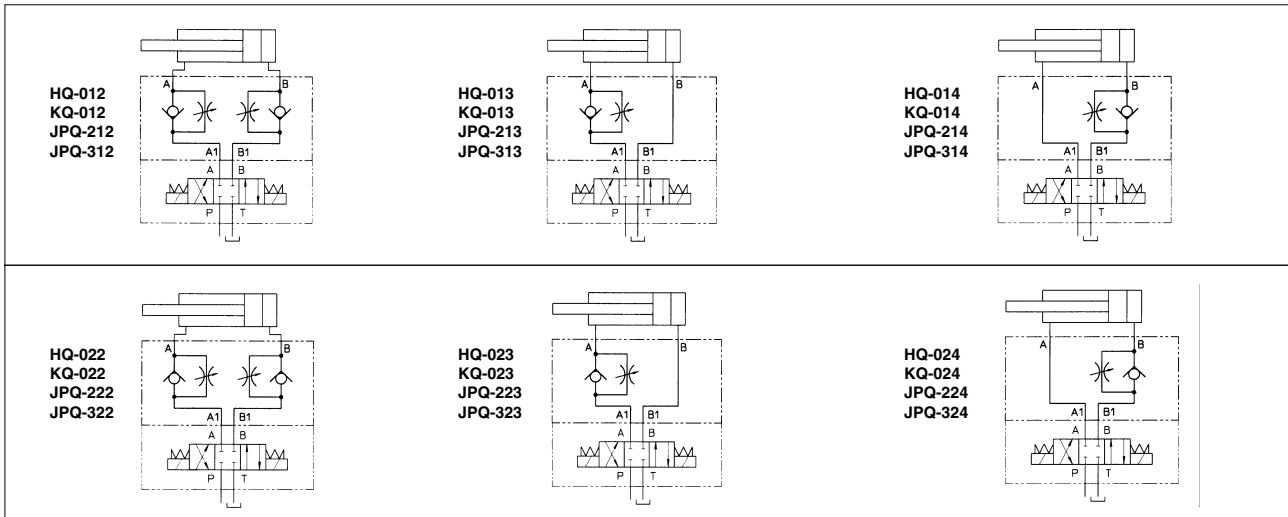

3 MAIN CHARACTERISTICS OF MODULAR FLOW CONTROL VALVES TYPE HQ, KQ, JPQ

Assembly position	Any position. JPQ cannot be associated with directional valves having hydraulic centring device because JPQ don't have the drain port.
Subplate surface finishing	Roughness index $\sqrt{0.4}$, flatness ratio 0,01/100 (ISO 1101)
Ambient temperature	-20°C to + 70°
Fluid	Hydraulic oil as per DIN 51524...535, for other fluids see section I
Recommended viscosity	15 ÷ 100 mm ² /s at 40°C (ISO VG 15 ÷ 100)
Fluid contamination class	ISO 19/16, achieved with in line filters at 25 µm value and $\beta_{25} \geq 75$ (recommended)
Fluid temperature	-20°C +60°C (standard and /WG seals) -20°C +80°C (/PE seals)

4 DIAGRAMS OF HQ-0 based on mineral oil ISO VG 46 at 50°C

- 1 = Regulation diagram at Δp 10 bar (1.1 = option /U)
- 2 = Regulation diagram at Δp 30 bar (2.1 = option /U)
- 3 = Regulation diagram at Δp 50 bar (3.1 = option /U)
- 4 = Q/ Δp diagram for free flow through the non-return valve

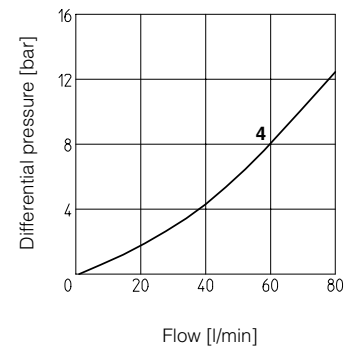
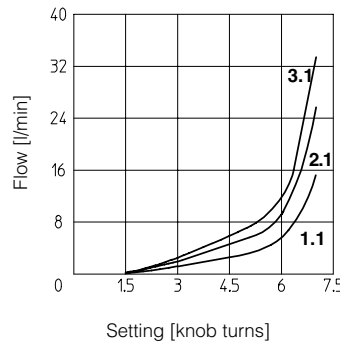
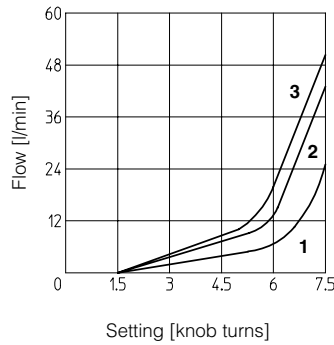

5 DIAGRAMS OF KQ-0 based on mineral oil ISO VG 46 at 50°C

- 1 = Regulation diagram at Δp 10 bar
- 2 = Regulation diagram at Δp 30 bar
- 3 = Regulation diagram at Δp 50 bar
- 4 = Q/ Δp diagram for free flow through the non-return valve

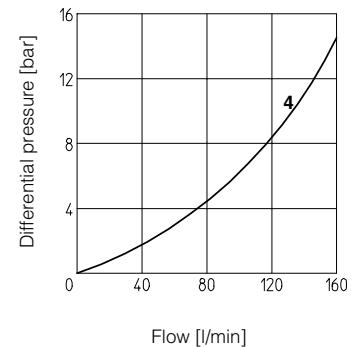
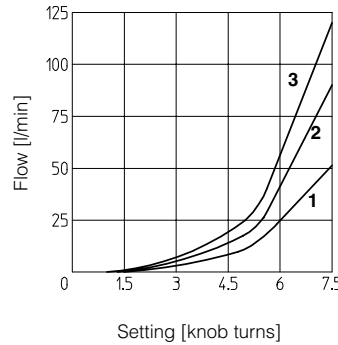

6 DIAGRAMS OF JPQ-2 based on mineral oil ISO VG 46 at 50°C

- 1 = Regulation diagram at Δp 10 bar
- 2 = Regulation diagram at Δp 30 bar
- 3 = Regulation diagram at Δp 50 bar
- 4 = Q/ Δp diagram for free flow through the non-return valve

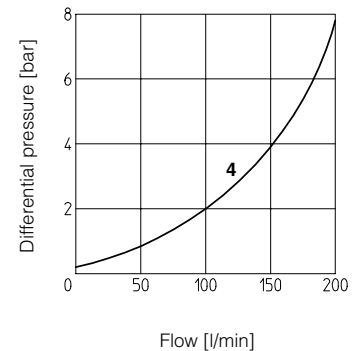
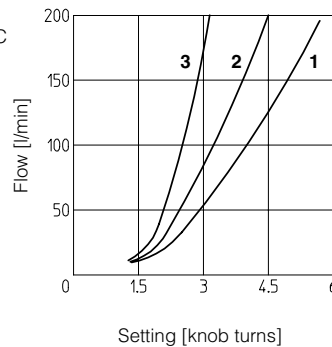

7 DIAGRAMS OF JPQ-3 based on mineral oil ISO VG 46 at 50°C

- 1 = Regulation diagram at Δp 10 bar
- 2 = Regulation diagram at Δp 30 bar
- 3 = Regulation diagram at Δp 50 bar
- 4 = Q/ Δp diagram for free flow through the non-return valve

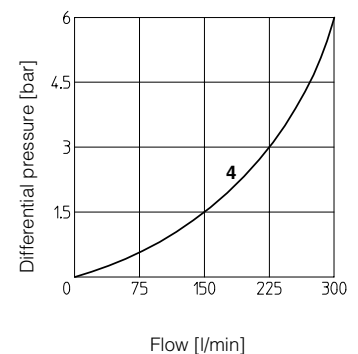
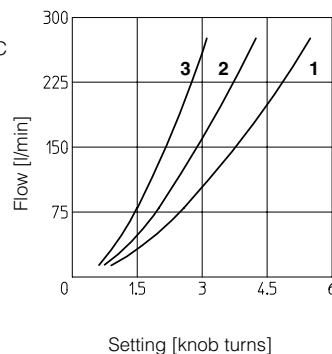

8 INSTALLATION DIMENSIONS OF HQ-0 VALVES [mm]

HQ-012
HQ-022

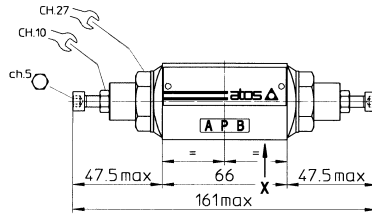
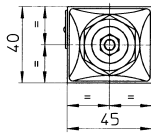

Mass: 1,1 Kg

HQ-013
HQ-014
HQ-023
HQ-024

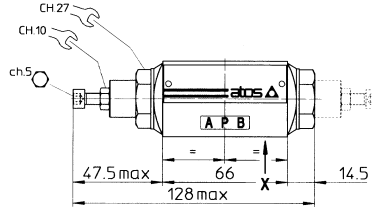
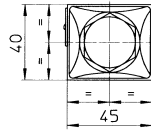

In version -014 and -024 the regulating element is on side of port B (dotted line) instead of side of port A.

Mass: 1,2 Kg

/G OPTION

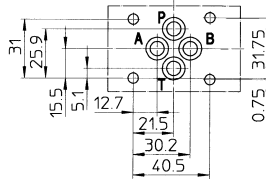
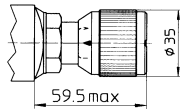
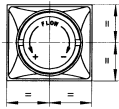

Mounting surface
ISO 4401-AB-03-4 size 06

Diameter of ports A, B, P, T: $\varnothing = 7,5$ mm (max)
Seals: 4 OR 108

Fastening bolts: n° 4 socket head screws M5. The length depends on number and type of modular elements associated.

9 INSTALLATION DIMENSIONS OF KQ-0 VALVES [mm]

KQ-012
KQ-022

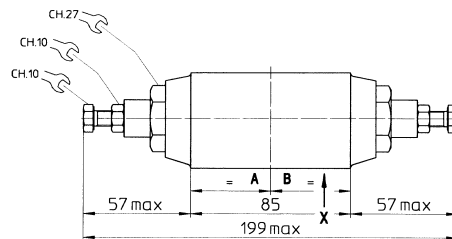
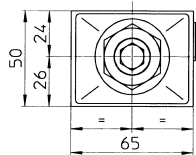

Mass: 2 Kg

KQ-013
KQ-014
KQ-023
KQ-024

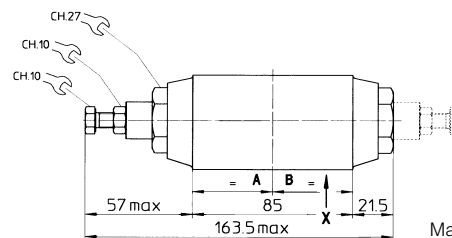
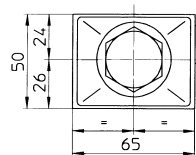

In version -014 and -024 the regulating element is on side of port B (dotted line) instead of side of port A.

Mass: 2,2 Kg

/G OPTION

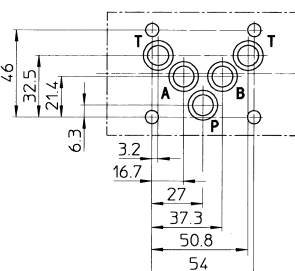
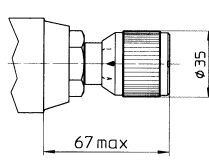
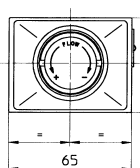

Mounting surface
ISO 4401-AC-05-4 size 10

Diameter of ports, A, B, P, T: $\varnothing = 11,2$ mm (max)
Seals: 5 OR 2050

Fastening bolts: n° 4 socket head screws M6. The length depends on number and type of modular elements associated.

10 INSTALLATION DIMENSIONS OF JPQ-2 VALVES [mm]

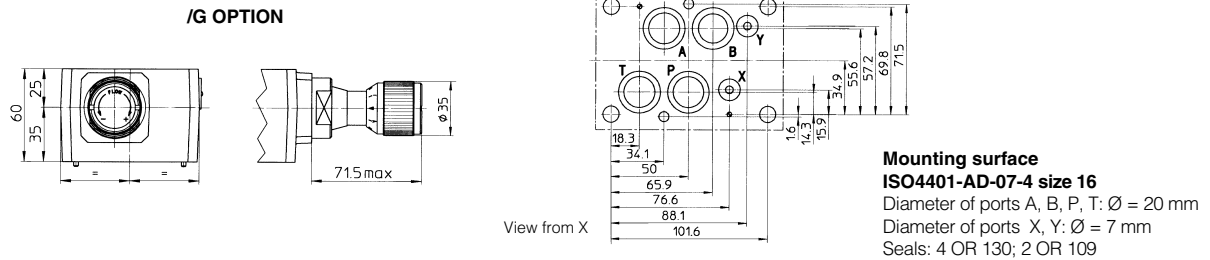
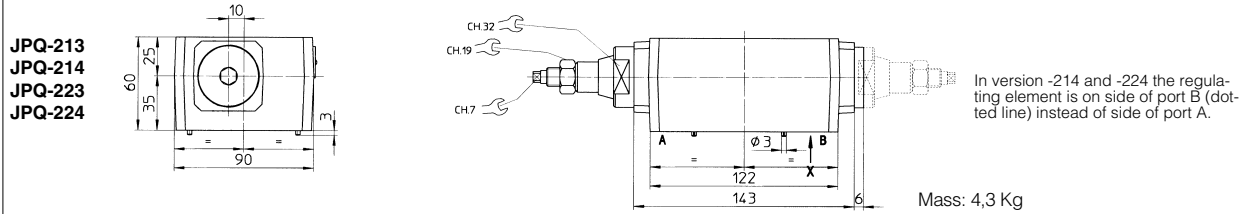
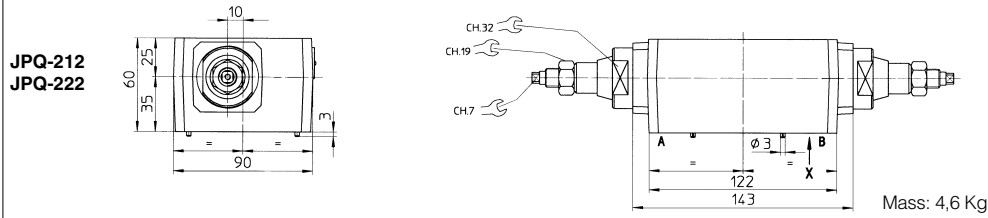

Fastening bolts: n° 4 socket head screws M10 and n° 2 M6. The length depends on number and type of modular elements associated.

11 INSTALLATION DIMENSIONS OF JPQ-3 VALVES [mm]

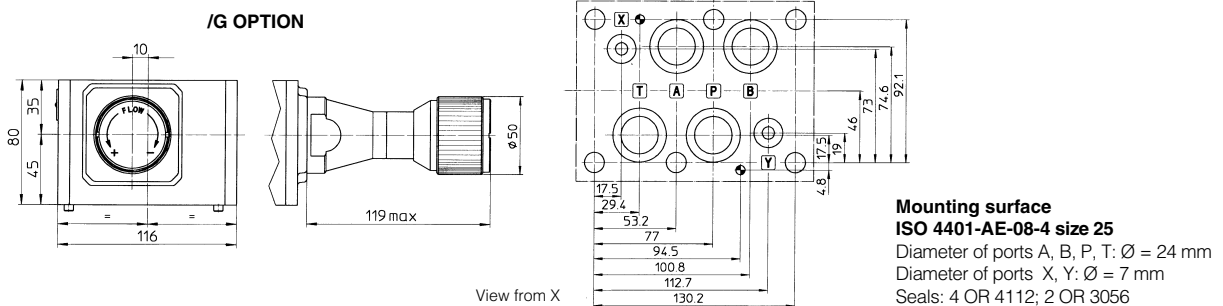
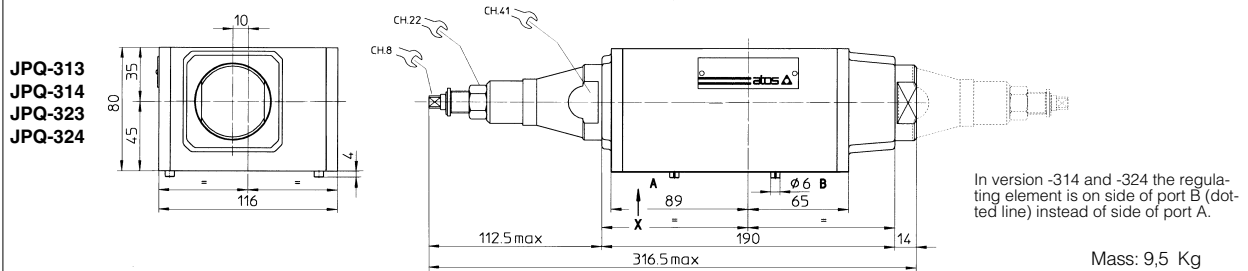
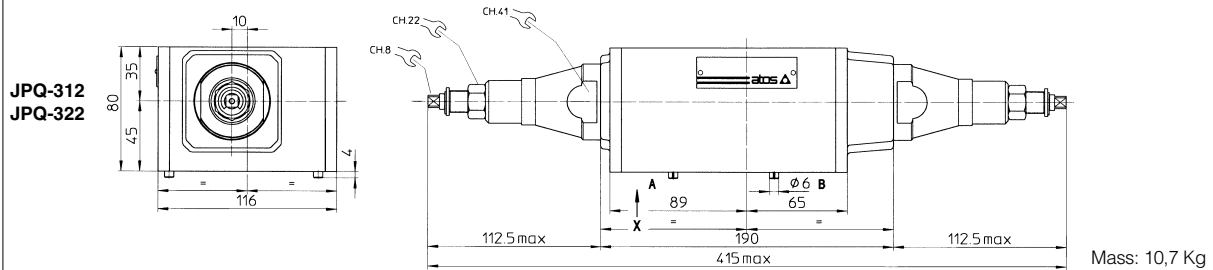

Fastening bolts: n° 6 socket head screws M12. The length depends on number and type of modular elements associated.